

VAPORIZZATORI GPL ELETTRICI Tipo feed-back

ATEX

LPG ELECTRIC VAPORIZERS EExd

VAPORISATEURS GPL ELECTRIQUE EExd

COPRIM - ITALY

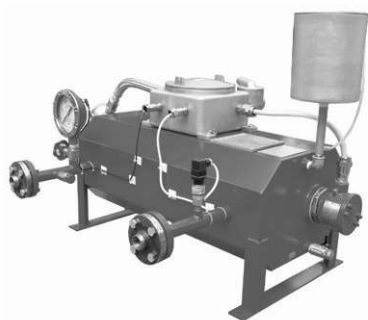

Box EExd
con termostati
EExd box containing
thermostat
boîte EExd contenant
thermostats



con quadro di comando
EExd
with EExd command board
avec tableau de contrôle
EExd

VAP.	Cod.
25 Kg/h	1.02.25
50 kg/h	1.02.26
100 Kg/h	1.02.27
150 Kg/h	1.02.28
200 Kg/h	1.02.29
300 Kg/h	1.02.30
500 Kg/h	1.02.31

VAP.	Cod.
25 Kg/h	1.02.35
50 kg/h	1.02.36
100 Kg/h	1.02.37
150 Kg/h	1.02.38
200 Kg/h	1.02.39
300 Kg/h	1.02.40
500 Kg/h	1.02.41

quadro IP55
non compreso
command board
excluded
tableau de bord
pas compris

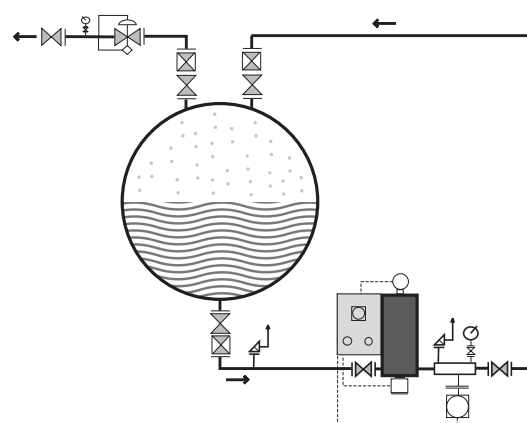
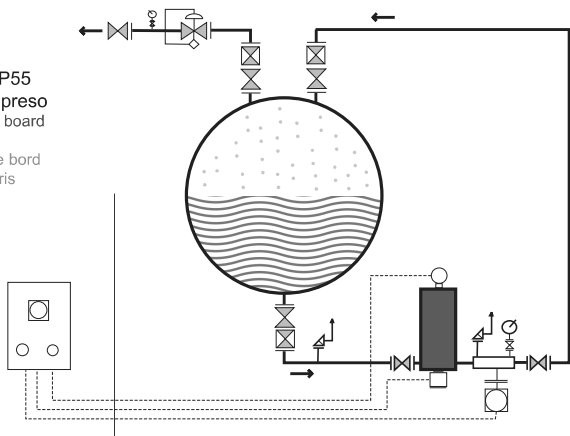

	INAIL 0100	PED Pressure Equipment Directive
	modulo H - H1	
	Garanzia di Qualità Totale	

temperatura progetto TS - 40 +120 °C

design temperature - température de projet

pressione progetto PS 40 bar

design pressure - pression de projet

SPECIFICA

- Manometro Ø60 25 bar con contatti
- Valvola di sicurezza 1/2" 18 bar
- Termometro -20 + 120 °C
- Vaschetta espansione acqua
- Resistenze elettr. EExd 8 kw
- Pressostato
- contenuto acqua + glicole

SPECIFICATIONS

- Pressure gauge Ø 60 25 bar with contact
- safety valve 1/2" 18 bar
- Thermometer -20 + 120 °C
- Water expansion pot
- Electrical resistances 8 kw
- Pressure switch
- water + glycol contained

SPÉCIFICATIONS

- Manomètre Ø60 25 bar
- Soupape de sécurité 1/2" 18 bar
- Thermomètre -20 + 120 °C
- Vase d'expansion eau
- Résistances électriques 8 kw
- Pressostat
- contenu eau + glycol

VAPORIZZATORI GPL ELETTRICI con termostati elettronici

LPG ELECTRIC VAPORIZER EExd with electronic thermostat

VAPORISATEUR GPL ELECTRIQUE EExd avec thermostats électroniques

COPRIM - ITALY

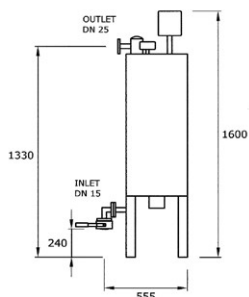

50 kg/h 8 kw

Cod. 1.01.641

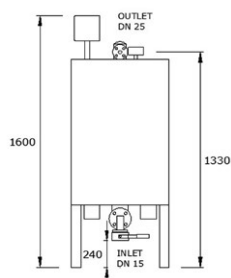
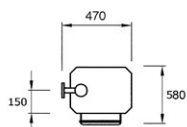

100 kg/h 16 kw

Cod. 1.01.661

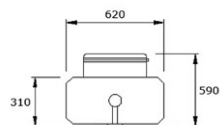

Equipaggiati con termostati elettronici

Equipped with electronic thermostat

Équipés avec thermostats électroniques

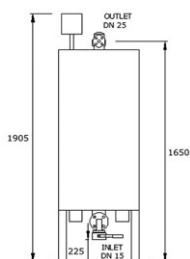

150 kg/h 24 kw

Cod. 1.01.681

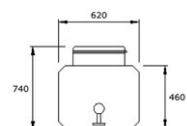

200 kg/h 32 kw

Cod. 1.01.701

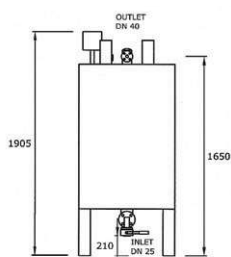

300 kg/h 48 kw

Cod. 1.01.721

400 kg/h 64 kw

Cod. 1.01.751

500 kg/h 80 kw

Cod. 1.01.801

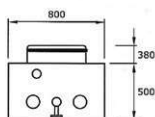

QUADRI ELETTRICI COMANDO VAPORIZZATORI GPL

Command boards for LPG vaporizers

Tableau de bord pour vaporisateurs GPL

COPRIM - ITALY

IP 55 (no EExd)

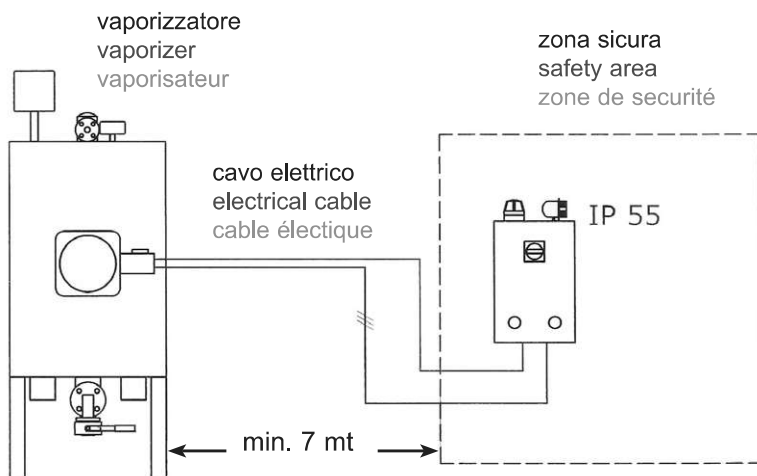

VAP	RES. EL	Cod.
25/E	4 Kw	1.06.10
50/E	8 Kw	1.06.20
100/E	16 Kw	1.06.30
150/E	24 Kw	1.06.40
200/E	32 Kw	1.06.50
300/E	48 Kw	1.06.60
400/E	64 Kw	1.06.65
500/E	80 Kw	1.06.70

QUADRO COMANDO ELETTROVALVOLA

Electrovalve command board

Tableau de bord électrovanne

Da posizionare in zona sicura

To be placed in safety area

A' positionner en zone de sécurité

Cod. 1.06.05



COMPLETI DI:

- Interruttore generale con blocco porta
- Fusibili di protezione
- Teleruttore
- Trasformatore per circuito di comando
- Relay di comando
- Lampada di segnalazione marcia - arresto
- Allarme visivo
- Allarme acustico

COMPLETE OF:

- Switch with door lock
- Safety fuses
- Contactors
- Transformer for control circuit
- Control relay
- Indicators light ON - OFF
- Visual alarm
- Acoustic alarm

COMPLET DE:

- Interrupteur avec bloc porte
- Fusibles de protection
- Contacteurs
- Transformateur pour circuit de contrôle
- Relay de commande
- Lampes de communication
- Allarme visuelle
- Allarme acoustique